

BS&B SAFETY SYSTEMS, L.L.C.
BS&B SAFETY SYSTEMS LTD.

Installation Instructions

Bulletin 77-4001I

Types S90™, JRS™, RLS™, and FRS™ Rupture Disk SRB-7RS™, SRB-7FS™, and S90-7R™ Safety Heads

Warning: Rupture disks are intended to provide a pressure relief opening. This rupture disk is designed to burst at a specified temperature and pressure, thereby relieving excess pressure or preventing excessive vacuum in a system. **It is imperative that this rupture disk be properly installed and safely vented in order to avoid bodily injury, damage to property, pollution and loss of product.** BS&B Safety Systems, L.L.C. and BS&B Safety Systems Ltd. supply disks selected by their customers, which are manufactured in reliance upon information and specifications supplied by the customer. BS&B Safety Systems, L.L.C. and BS&B Safety Systems Ltd. are not liable for any damage resulting from improper installation, improper system design, unsafe venting, or other factors beyond BS&B Safety Systems, L.L.C. and BS&B Safety Systems Ltd. control. Do not locate the rupture disk device where personnel, equipment or property will be exposed to released product and pressure through the disk. Handle carefully, disk and tag may have sharp edges.

Order Replacement Disks by Lot Number (Shown on disk's tag).

Before you Install a Rupture Disk

1. Inspect Safety Head

Inspect safety head's mating surfaces for foreign material. Pits, dust or grit can damage the bursting disk affecting disk performance or cause leakage. If surfaces are rough, polish with a fine emery cloth. Clean if necessary. Do not machine safety head holder, dimensions are critical. Inspect safety head bore for product build-up or corrosion. Clean as appropriate; do not re-machine or use a damaged safety head.

The safety head size and pressure rating must match the companion pipe flange size and rating. Ensure that appropriate adjustments are made for temperature when reviewing flange rating compatibility.

2. Inspect Pipe Flanges

Ensure the pipe flanges are parallel to a sufficient standard that will permit proper function of both the rupture disk device and the chosen pipe flange gaskets.

3. Inspect Rupture Disk

Prior to assembly ensure that the model/type of safety head (holder) to be used is compatible with the rupture disk type, using the chart on this page of these instructions. For 'CE' marked disks, the disk tag identifies the holder types that may be used. The rupture disk burst pressure must not exceed the safety head and pipe flange rating. Handle the rupture disk carefully, holding the disk

by the tag and the perimeter only.

Examine both sides of the disk checking the seating and domed surfaces for nicks, dents, scratches and foreign material, which can damage the disk, cause leakage or affect the burst pressure. Do not install a damaged disk. Installation of a damaged disk may result in premature bursting of the disk. If damaged the S90™, JRS™ and RLS™ disks may burst at up to 1.5 times the marked burst pressure. If damaged the FRS™ disk will burst at or below its marked burst pressure.

RUPTURE DISK	USE IN SAFETY HEAD TYPE
S90™	SRB-7RS™, SRB-7FS™, S90-7R™
JRS™	SRB-7RS™ and SRB-7FS™
FRS™	SRB-7RS™, SRB-7FS™, S90-7R™
RLS™	SRB-7RS™ and SRB-7FS™

The following Patents apply: **RLS™** US 4,404,982, CN 1174556, F 82.20240, GB 2114666, I 1154365, D 3224233, CN 1229540, F 83.20791, GB 2133083, I 1168745; **S-90™** US 4,441,350, 4,481,850, CN 1191338; **FRS™** US 5,082,133, 4,576.303, CN 1238610, GB 2171760, F 85.13716, J 1702677, D 3532395
For CE marked disks the tag identifies holder types SRB-7RS™ and SRB-7FS™ as 'Type S', and holder type S90-7R™ as 'Type SI'.

1

See our Internet site at www.bsbsystems.com or www.bsb.ie for updates!



Safety Precautions - Caution

- ◆ Only competent, trained personnel should install rupture disk safety devices in accordance with these installation instructions.
- ◆ Consider recoil. Provide adequate support for piping and connections to absorb recoil/reaction forces when the disk ruptures. Recoil is the force the system will experience upon disk rupture. Recoil (lbs) is approximately twice the disk's burst pressure (psig) times the relief area (in.²). If the discharge is free vented, a baffle plate may be mounted down-stream of the outlet companion pipe flange with extra length studs to minimize recoil.
- ◆ Do not remove rupture disks from packaging for inspection until ready to install.
- ◆ The rupture disk and safety head should not be subjected to excessive structural bending stresses.
- ◆ If disks are liquid or steamed cleaned, and a high velocity particle spray or jet is used, take care not to damage the disk.
- ◆ Do not locate the disk where it may be subjected to thermal shock. Moisture, rain, condensation or snow may cause a thermal shock to the disk causing the disk to burst below its marked burst pressure. A protector is recommended for temperatures above 212°F (100°C), consult BS&B Safety Systems, L.L.C. or BS&B Safety Systems Ltd.
- ◆ Where a disk is mounted upstream of a pressure relief or safety valve, ensure that the opening of the disk does not interfere or effect the performance of the valve.
- ◆ When the disk ruptures, ensure that the opening of the disk does not affect the performance of downstream equipment. The bursting of a disk may result in a pressure shock wave.
- ◆ Do not reinstall a disk that has been removed from the piping system unless used in a pre-torqued safety head. When stresses in the disk are relieved by removing it from the safety head the disk can never resume its original installed condition, which can affect disk performance.
- ◆ Only pre-torqued safety heads (SRB-7RS™ and SRB-7FS™) with the contained rupture disk may be removed from service and re-installed provided the capscrews are not loosened, the capscrew torque is maintained and the disk is in good condition.
- ◆ The rupture disk and safety head must not be machined or modified in any way except with the approval of BS&B Safety Systems, L.L.C. or BS&B Safety Systems Ltd. Failure to obtain such approval voids the warranty on this product.
- ◆ Safety head and rupture disk materials should be compatible with your process.
- ◆ Corrosion and process conditions may deteriorate disk performance and necessitate frequent replacement.
- ◆ Warning: Should a rupture disk type RLS™, JRS™, or FRS™ and its safety head be installed upside down, the burst pressure generally exceeds 1.5 times the marked burst pressure. Should an S-90™ rupture disk and its safety head be installed upside down, the burst pressure shall not exceed 1.5 times the marked burst pressure.

Installation of Rupture Disk in SRB-7RS™ Safety Head

(Refer to Figure 1)

1. Place inlet of safety head on a flat work surface in position as shown with flow arrows and locating pins up. (Please refer to the drawing in Figure 1 that corresponds to the nominal disk size and safety head rating to be installed)
2. Place NEW, UNDAMAGED, rupture disk on inlet so locating pins mate with the corresponding holes in the rupture disk flange.
3. Carefully align and place safety head outlet flange in position as shown. Ensure flow arrows on the disk tag and on the safety head point in the same direction.
4. Assemble unit with twelve point capscrews. Tighten the twelve point high strength capscrews with socket (See torque table as identified in these instructions for socket type) finger tight before torquing. DO NOT SUBSTITUTE for capscrews supplied. Do not lubricate blue fluoropolymer coated capscrews.
5. Evenly torque the capscrews to the value shown in Table A when using uncoated capscrews or Table B

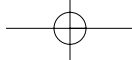
**(continued from page 2)**

when using blue color fluoropolymer coated cap-screws. Torque evenly in a diagonal pattern by applying 1/4 of the torque value to cap screw (1), and then applying torque to (2), (3) and (4) etc. Repeat the torquing pattern for 1/2 then 3/4 of the recommended torque value. Finally using same pattern, torque to full torque value. Note: Uneven or under-torquing can cause disk rupture below its marked burst pressure. Excessive torquing can cause damage to the disk and safety head. Use the correct

socket and torque wrench with appropriate torque value range. The torque wrench must be calibrated.

6. The twelve point cap screw heads should be recessed into the SRB-7RS™ safety head outlet after installation.
7. Sizes 2" (50mm) and above have a "bite type" seal on the SRB-7RS™ inlet face that engages with the rupture disk. Do not modify this feature in any way. Should the "bite-type" seal be incomplete or damaged contact BS&B Safety Systems, L.L.C. or BS&B Safety Systems Ltd. for repair.

Installation of Safety Head SRB-7RS™ Assembly in Pressure System

(Refer to Figure 2 and 3)

1. Insert the safety head assembly into the pressure system between companion flanges. **Ensure flow arrows on the safety head and disk tag point in the desired flow direction upon disk rupture.** The SRB-7RS™ centers inside the bolting pattern of pipe flanges and a J-bolt prevents the safety head from being installed incorrectly with respect to flow, see Fig 2. The inlet companion flange must be radially drilled to accept the J-bolt. Table D lists companion flange drilling dimensions. Locate the J-bolt in the drilled hole. Do not remove or damage the J-bolt.
2. Install gaskets between the safety head and the companion flanges. We recommend a compressed fiber gasket 1/16" (1.5 mm) or 1/8" (3 mm) thick. The user is cautioned to select gasket materials adequate for the service conditions including the ability of the gasket to resist "cold flow". Gaskets that cold flow will allow torque relaxation affecting their sealing performance. (The burst pressure of disks installed in pre-torqueable Safety Heads SRB-7RS™ is unaffected.) **Contact BS&B Safety Systems, L.L.C. or BS&B Safety Systems Ltd. if an alternative gasket type is used, or for advice on the use of spiral wound gaskets.**
3. Install studs with nuts. Studs with nuts should be free running with lightly oiled threads, see Table K for stud details. Tighten all nuts finger tight. Torque the nuts to the value shown in Table C. Torque evenly in a diagonal pattern by applying 1/4 of the recommended torque to each stud. Repeat pattern by torquing to 1/2 then 3/4 of the recommended torque value. Then using same pattern, torque to full torque value. Do not exceed the specified torque value.
4. The torque value on the companion flange nuts should be verified periodically.

Installation of S-90™ or FRS™ Type Rupture Disk in a Quik-Sert™ S90-7R™ Safety Head

(Refer to Figure 4)

1. Place inlet of safety head on a work surface in position shown in Figure 4 with flow arrows and locating pins up.
2. Place NEW UNDAMAGED, rupture disk on inlet flange so locating pins mate with the corresponding holes in the rupture disk. Flow arrows on disk tag indicate direction of flow.
3. Carefully align and place outlet flange in position as shown. **Ensure flow arrows on the disk tag and on the Safety Head point in the same direction.**
4. Assemble unit with pre-assembly lugs and pre-assembly screws. Tighten pre-assembly screws finger tight, only sufficient to hold disk snugly in place between the two flanges. Some movement between the disk and the safety head will remain.
5. Sizes 2" (50mm) and above have a "bite-type" seal on the inlet face that engages with the rupture disk. Do not modify this feature in any way. Should the "bite-type" seal be incomplete or damaged, contact BS&B Safety Systems, L.L.C. or BS&B Safety Systems Ltd for repair.

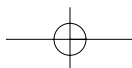

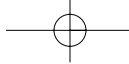

Installation of Safety Head S90-7R™ Assembly in Pressure System

(Please note the S90-7R™ Safety Head is not a pre-torqued holder)
(Refer to Figure 5)

1. Insert the safety head assembly into the pressure system between companion pipe flanges. **Ensure flow arrows on the disk tag and safety head point in desired flow direction upon disk rupture.** The S90-7R™ centers inside the bolting pattern of pipe flanges, see Figure 5.
2. Install gaskets between safety head and companion pipe flanges. We recommend a compressed fiber gasket 1/16" (1.5mm) or 1/8" (3 mm) thick. The user is cautioned to select gasket materials adequate for the service conditions including the ability of the gasket to resist "cold flow". Gaskets that cold flow will allow torque relaxation affecting their sealing performance and may cause low bursts. **Contact BS&B Safety Systems, L.L.C. or BS&B Safety Systems Ltd. if an alternative gasket type is used, or for advice on the use of spiral wound gaskets.**
3. Install studs with nuts, which should be free running with lightly oiled threads. Tighten all nuts finger tight. Torque the nuts to the value shown in Table J. Torque evenly in a diagonal pattern by applying 1/4 of the recommended torque to each stud. Repeat pattern by torquing to 1/2 then 3/4 of the recommended torque value. Then using same pattern, torque to full specified torque value. Do not exceed the specified torque value.
4. The torque value on the companion flange nuts should be verified periodically.
Note: Uneven or under-torquing can cause disk rupture below its marked burst pressure. Excessive torquing can cause damage to the disk and Safety Head.

Installation of Rupture Disk in SRB-7FS™ Safety Head

1. Follow Instructions 1-7 on page 2 and 3, using Torque Table E, F, G or H as determined by the Safety Head material and the use of uncoated or blue color fluoropolymer coated capscrews.
2. Evenly torque the capscrews to the values shown in the tables.

Torque Table	SRB-7FS™ Type
E	Material Nickel, Uncoated Capscrews
F	Material Nickel, Blue Fluoropolymer Coated Capscrews
G	With RTJ, Uncoated Capscrews
H	With RTJ, Blue Fluoropolymer Coated Capscrews

Installation of Safety Head SRB-7FS™ Assembly in Pressure System

(Refer to Figure 6)

1. Insert the preassembled SRB-7FS™ safety head in the pressure system. **Ensure flow arrows on the disk tag and on the safety head point in the same direction.** Concave side of disk, must be away from process.
2. Install gaskets between the safety head and the companion flanges. We recommend a compressed fiber gasket 1/16" (1.5 mm) or 1/8" (3 mm) thick. The user is cautioned to select gasket materials adequate for the service conditions including the ability of the gasket to resist "cold flow." Gaskets that cold flow will allow torque relaxation affecting their sealing performance. (The burst pressure of disks installed in pre-torqueable safety heads SRB-7RS™ is unaffected.) **Contact BS&B Safety Systems, L.L.C. or BS&B Safety Systems Ltd. if an alternative gasket type is used, or for advice on the use of spiral wound gaskets.**
3. Install studs with nuts. Tighten all nuts finger tight before torquing. Evenly torque the studs to the values in Table C. Torque evenly in a diagonal pattern by applying 1/4 of the recommended torque to each stud. Repeat pattern by torquing to 1/2 then 3/4 of the recommended torque value. Then using same pattern, torque to full torque value. Do not exceed the specified torque value.

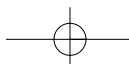

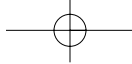

**Figure 1
Safety Head Type SRB-7RS™**

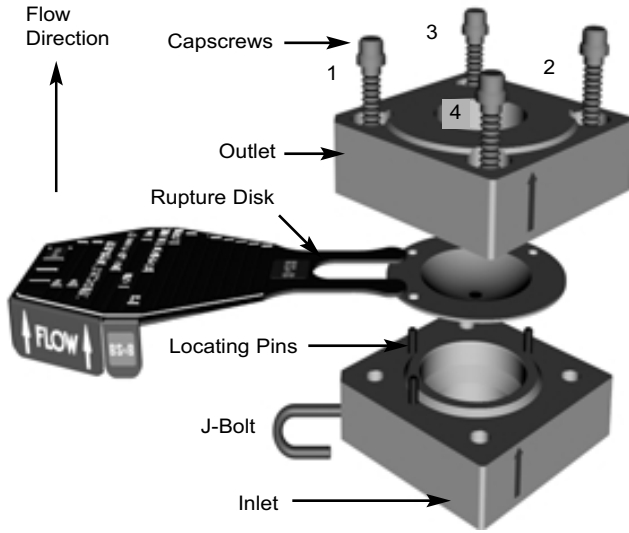

1" (25 mm) ANSI 150/300/600/900/1500
DIN 10/16/25/40
JIS 10/16/20/30/40

1 1/2" (40mm) ANSI 150/300/600/900/1500
DIN 10/16/25/40
JIS 10/16/20/30/40

2" (50mm) ANSI 900/1500

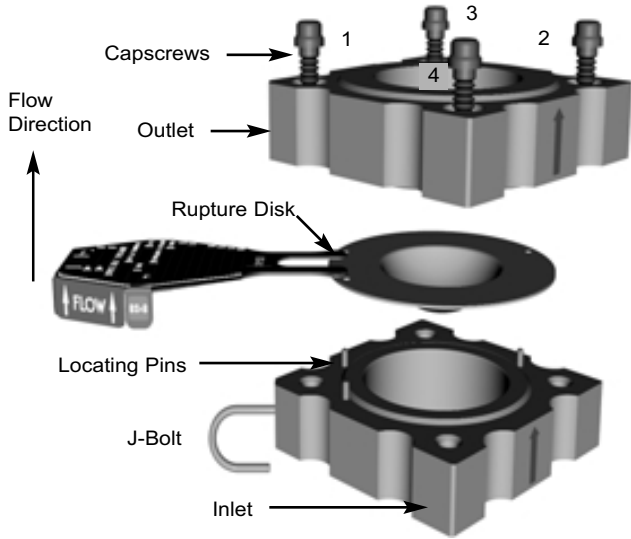

2" (50mm) ANSI 150/300/600
DIN 10/16/25/40
JIS 10/16/20/30/40

3" (80mm) ANSI 150/300/600
DIN 10/16/25/40
JIS 10/16/20/30/40

4" (100mm) ANSI 150/300
DIN 10/16/25/40
JIS 10/16/20/30/40

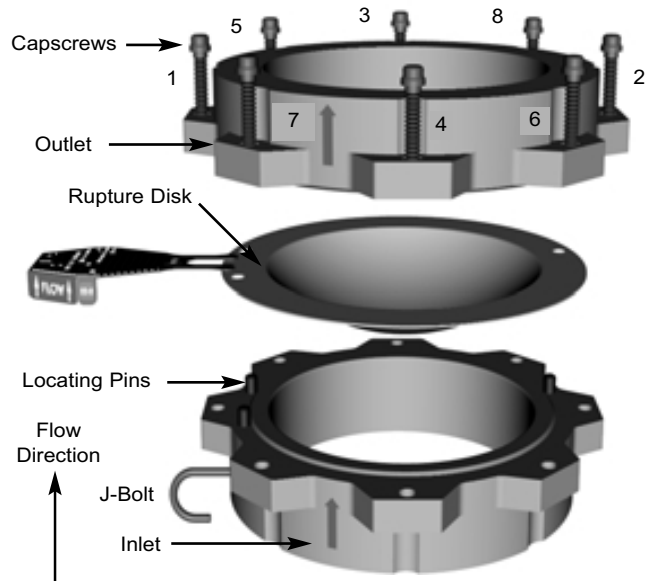

6" (150mm) ANSI 150/300
DIN 10/16/25/40
JIS 10/16/20/30/40

8" (200mm) ANSI 150/300
DIN 10

(For larger sizes, Safety Head configuration is similar to 6" and 8")

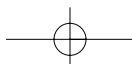

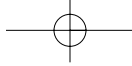
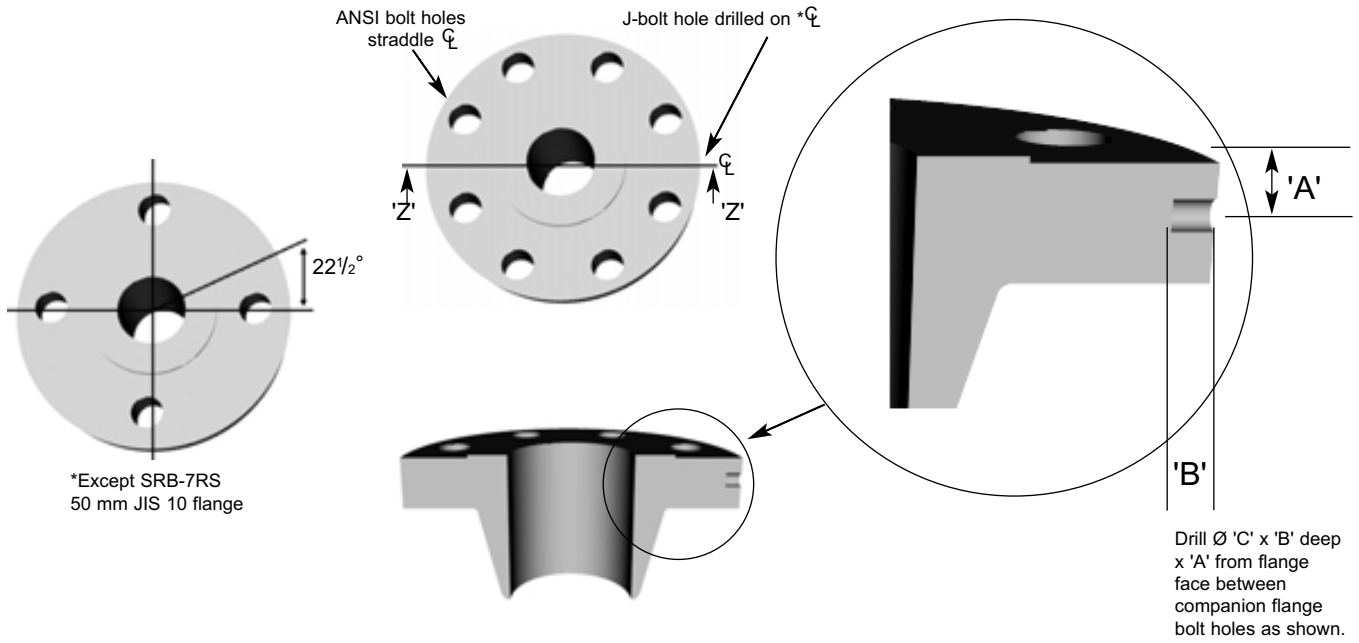

Figure 2
Inlet Companion Flange Drilling to accept J-Bolt



J-Bolt Drilling

The SRB-7RS™ (See Fig 2) fits inside the bolting pattern of the companion flange. The J-bolt prevents the safety head from being installed upside down. The inlet companion flange must be drilled to accept the J-bolt. See Table D for SRB-7RS™ companion flange drilling instructions. The SRB-7FS™ also uses the J-bolt to prevent upside down installation. Refer to Table I for SRB-7FS™ companion flange drilling instructions.

**SRB-7RS™ Installed
 In Companion Flange**

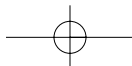
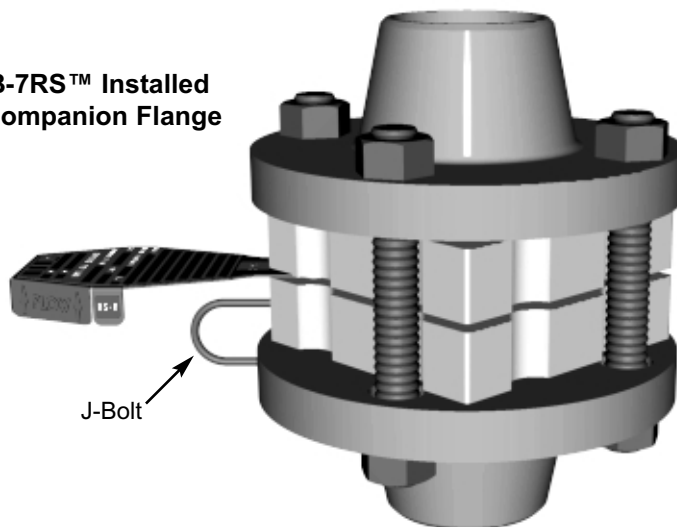

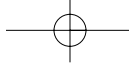

Figure 3
SRB-7RS™ Safety Head Companion Flange Bolting Pattern
(Capscrews removed for clarity)

Refer to the drawing that corresponds to the Safety Head Size and Flange Rating



1" (25 mm) ANSI 150/300/600/900/1500
 DIN 10/16/25/40
 JIS 10/16/20/30/40
 1 1/2" (40mm) ANSI 150/300/600/900/1500
 DIN 10/16/25/40
 JIS 10/16/20/30/40



2" (50mm) JIS 10



2" (50mm) ANSI 300/600
 JIS 16/20/30/40
 3" (80mm) ANSI 300/600
 DIN 10/16/25/40
 JIS 10/16/20/30/40
 4" (100mm) ANSI 150/300
 DIN 10/16/25/40
 JIS 10/16/20/30/40

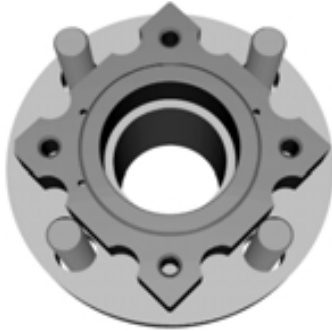

2" (50mm) ANSI 150
 DIN 10/16/25/40
 3" (80mm) ANSI 150



2" (50mm) ANSI 900/1500



6" (150mm) ANSI 150
 DIN 10/16/25/40
 JIS 10
 8" (200mm) ANSI 150
 DIN 10



6" (150mm) ANSI 300
 JIS 16/20/30/40
 8" (200mm) ANSI 300
 (For larger sizes, configuration is similar to 6" and 8".)

SRB-7RS™ Installed In Companion Flange

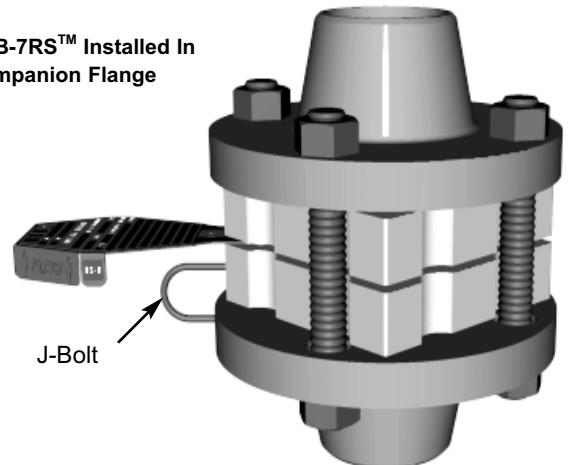

J-Bolt

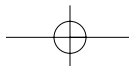

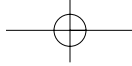
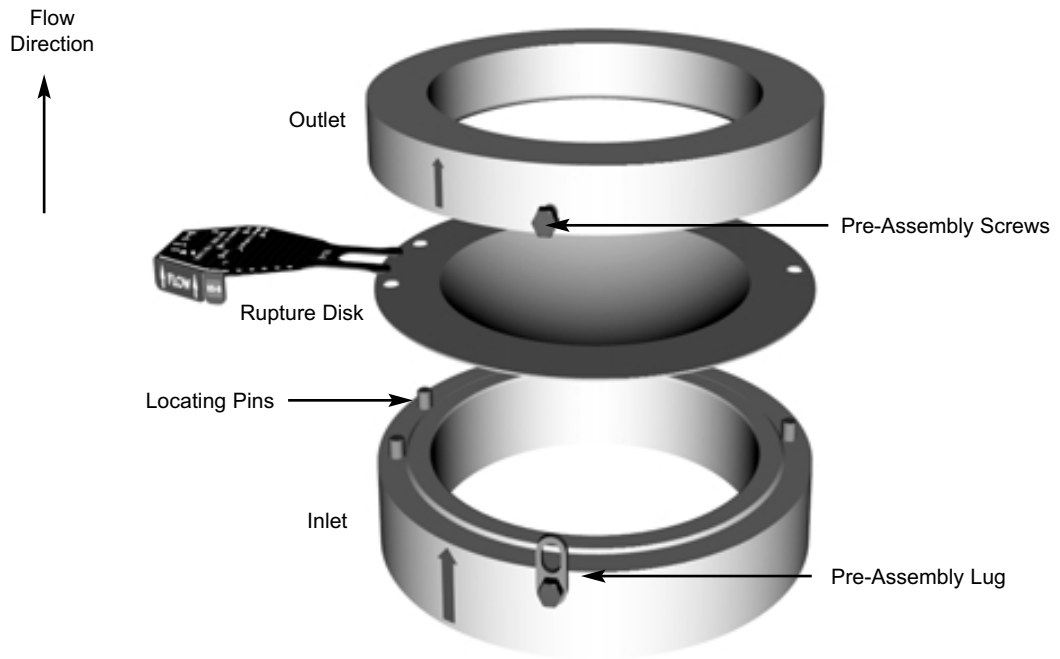
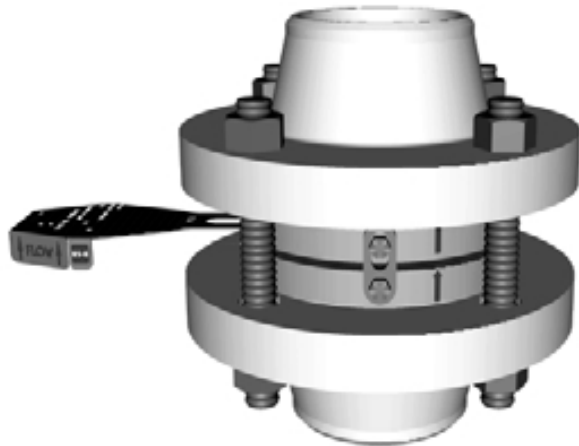

Figure 4
S90™ Rupture Disk in Quik-Sert™ S90-7R™ Safety Head



Type S90-7R™ Safety Head

Figure 5
Installation of Safety Head S90-7R™ Assembly in Pressure System



The S90-7R™ locates within the bolting pattern of companion flanges.

Figure 6
Installation of Safety Head SRB-7FS™ Assembly in Pressure System

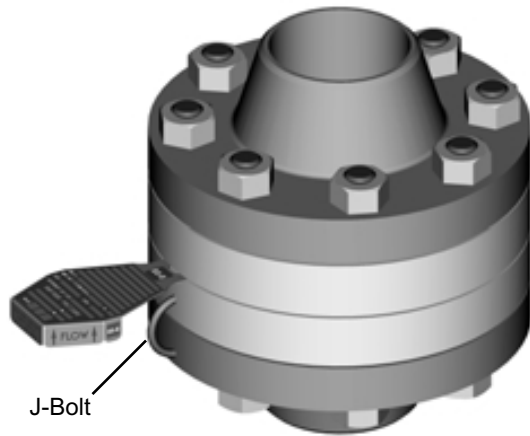

Note: The SRB-7FS™ is available for those applications where RTJ or tongue and groove safety heads are required or where nickel is desired as the safety head material.

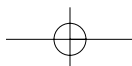

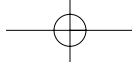

TORQUE TABLE A - Uncoated Capscrews
SRB-7RS™ PRE-ASSEMBLY CAPSCREW TORQUE
(NOT FOR SRB-7FS™)

SIZE		SAFETY HEAD FLANGE RATING			PREASSEMBLY CAPSCREW TORQUE						12 POINT SOCKET SIZE	SOCKET DRIVE *	SUGGESTED SOCKET SOURCE SNAP-ON® TOOLS
					TYPE S90™ AND TYPE FRS™				TYPE JRS™ AND TYPE RLS™				
					ALUMINUM		OTHER MATERIAL						
IN	MM	ANSI	DIN	JIS	FT-LB	NT-M	FT-LB	NT-M	FT-LB	NT-M	IN	IN	
1	25	150	10/16	10/16	11	15	11	15	17	23	1/4	3/8	SF-081
1	25	300/600	25/40	20/30/40	-	-	17	23	17	23	1/4	3/8	SF-081
1	25	900/1500	-	-	-	-	-	-	60**	81**	3/8	3/8	SF-121
1.5	40	150	10/16	10/16	20	27	20	27	30	41	5/16	3/8	SF-101
1.5	40	300/600	25/40	20/30/40	-	-	30	41	30	41	5/16	3/8	SF-101
1.5	40	900/1500	-	-	-	-	-	-	65**	88**	3/8	3/8	SF-121
2	50	150	10/16	10/16	26	35	26	35	34	46	5/16	3/8	SF-101
2	50	300/600	25/40	20/30/40	-	-	34	46	34	46	5/16	3/8	SF-101
2	50	900/1500	-	-	-	-	-	-	100**	136**	1/2	1/2	SW-161
3	80	150	10/16	10/16	41	55	41	55	65	88	3/8	3/8	SF-121
3	80	300/600	25/40	20/30/40	-	-	65	88	65	88	3/8	3/8	SF-121
3	80	900	-	-	-	-	-	-	140**	190**	1/2	1/2	SW-161
4	100	150	10/16	10/16	62	84	75	102	102	138	7/16	3/8	SF-141
4	100	300	25/40	20/30/40	-	-	102	138	102	138	7/16	3/8	SF-141
4	100	600	-	-	-	-	53	72	53	72	3/8	3/8	SF-121
6	150	150	10/16	10/16	40	54	47	64	60	81	3/8	3/8	SF-121
6	150	300	25/40	20/30/40	-	-	60	81	60	81	3/8	3/8	SF-121
6	150	600	-	-	-	-	97	132	97	132	7/16	3/8	SF-141
8	200	150	-	-	-	-	70	95	84	114	7/16	3/8	SF-141
8	200	300	-	-	-	-	84	114	84	114	7/16	3/8	SF-141
10	250	150	-	-	-	-	61	83	69	94	7/16	3/8	SF-141
10	250	300	-	-	-	-	69	94	69	94	7/16	3/8	SF-141
12	300	150	-	-	-	-	29	39	29	39	5/16	3/8	SF-101
12	300	300	-	-	-	-	50	68	50	68	7/16	3/8	SF-141
14	350	150	-	-	-	-	58	79	58	79	3/8	3/8	SF-121
14	350	300	-	-	-	-	98	133	98	133	7/16	3/8	SF-141
16	400	150	-	-	-	-	80	108	80	108	7/16	3/8	SF-141
16	400	300	-	-	-	-	195	264	195	264	5/8	1/2	SW-201
18	460	150	-	-	-	-	120	163	120	163	1/2	1/2	SW-161
18	460	300	-	-	-	-	195	264	195	264	5/8	1/2	SW-201
20	500	150	-	-	-	-	120	163	120	163	1/2	1/2	SW-161
20	500	300	-	-	-	-	195	264	195	264	5/8	1/2	SW-201
24	600	150	-	-	-	-	195	264	195	264	5/8	1/2	SW-201
24	600	300	-	-	-	-	350	475	350	475	3/4	1/2	SW-241
30***	750	-	-	-	-	-	95	129	95	129	1/2	1/2	SW-161
36***	900	-	-	-	-	-	-	-	100	136	5/8	1/2	SW-201

*12 point, deep length, thin wall socket.

**For Type RLS™ only.

***30" and 36" to fit MSS SP-44 Class 150 flange bolting.

The torque values in the table above are based on the assumption of lightly oiled, clean, free running threads with a coefficient of friction of $\mu=0.16 \sim 0.20$. The affects of corrosion, the use of particular thread compounds, or dry assembly may result in a change in the effective clamp load on the disk assembly. This may adversely affect the performance of the disk. Snap-On® is a registered trademark of Snap-On Technologies Incorporated.

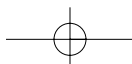

TORQUE TABLE B - Blue Coated Capscrews
SRB-7RS™ PRE-ASSEMBLY CAPSCREW TORQUE
(NOT FOR SRB-7FS™)

(Blue Coated Capscrews, Max Temperature 500 °F 260 °C)

SIZE	SAFETY HEAD FLANGE RATING			PREASSEMBLY CAPSCREW TORQUE						12 POINT SOCKET SIZE	SOCKET DRIVE *	SUGGESTED SOCKET SOURCE SNAP-ON® TOOLS
				TYPE S90™ AND TYPE FRS™				TYPE JRS™ AND TYPE RLS™				
				ALUMINUM		OTHER MATERIAL						
IN	ANSI	DIN	JIS	FT-LB	NT-M	FT-LB	NT-M	FT-LB	NT-M	IN	IN	
1	150	10/16	10/16	6	8	6	8	9	12	1/4	3/8	SF-081
1	300/600	25/40	20/30/40	-	-	9	12	9	12	1/4	3/8	SF-081
1	900/1500	-	-	-	-	-	-	30**	41**	3/8	3/8	SF-121
1.5	150	10/16	10/16	10	14	10	14	15	20	5/16	3/8	SF-101
1.5	300/600	25/40	20/30/40	-	-	15	20	15	20	5/16	3/8	SF-101
1.5	900/1500	-	-	-	-	-	-	33**	45**	3/8	3/8	SF-121
2	150	10/16	10/16	13	18	13	18	17	23	5/16	3/8	SF-101
2	300/600	25/40	20/30/40	-	-	17	23	17	23	5/16	3/8	SF-101
2	900/1500	-	-	-	-	-	-	50**	68**	1/2	1/2	SW-161
3	150	10/16	10/16	21	28	21	28	33	45	3/8	3/8	SF-121
3	300/600	25/40	20/30/40	-	-	33	45	33	45	3/8	3/8	SF-121
3	900	-	-	-	-	-	-	70**	95**	1/2	1/2	SW-161
4	150	10/16	10/16	31	42	38	52	51	69	7/16	3/8	SF-141
4	300	25/40	20/30/40	-	-	51	69	51	69	7/16	3/8	SF-141
4	600	-	-	-	-	27	37	27	37	3/8	3/8	SF-121
6	150	10/16	10/16	20	27	24	33	30	41	3/8	3/8	SF-121
6	300	25/40	20/30/40	-	-	30	41	30	41	3/8	3/8	SF-121
6	600	-	-	-	-	49	66	49	66	7/16	3/8	SF-141
8	150	-	-	-	-	35	47	42	57	7/16	3/8	SF-141
8	300	-	-	-	-	42	57	42	57	7/16	3/8	SF-141
10	150	-	-	-	-	31	42	35	47	7/16	3/8	SF-141
10	300	-	-	-	-	35	47	35	47	7/16	3/8	SF-141
12	150	-	-	-	-	15	20	15	20	5/16	3/8	SF-101
12	300	-	-	-	-	25	34	25	34	7/16	3/8	SF-141
14	150	-	-	-	-	29	39	29	39	3/8	3/8	SF-121
14	300	-	-	-	-	49	66	49	66	7/16	3/8	SF-141
16	150	-	-	-	-	40	54	40	54	7/16	3/8	SF-141
16	300	-	-	-	-	98	133	98	133	5/8	1/2	SW-201
18	150	-	-	-	-	60	81	60	81	1/2	1/2	SW-161
18	300	-	-	-	-	98	133	98	133	5/8	1/2	SW-201
20	150	-	-	-	-	60	81	60	81	1/2	1/2	SW-161
20	300	-	-	-	-	98	133	98	133	5/8	1/2	SW-201
24	150	-	-	-	-	98	133	98	133	5/8	1/2	SW-201
24	300	-	-	-	-	175	237	175	237	3/4	1/2	SW-241
30***	-	-	-	-	-	48	65	48	65	1/2	1/2	SW-161
36***	-	-	-	-	-	-	-	50	68	5/8	1/2	SW-201

*12 point, deep length, thin wall socket.

**For Type RLS™ only.

***30" and 36" to fit MSS SP-44 Class 150 flange bolting.

Do not lubricate blue fluoropolymer coated capscrews.

Snap-On® is a registered trademark of Snap-On Technologies Incorporated.

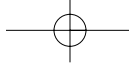

TORQUE TABLE C
COMPANION FLANGE STUD TORQUE
SRB-7RS™, SRB-7FS™ AND SRB-7FS™ (with RTJ)
(Applicable to all capscrew materials)

SIZE		COMPANION FLANGE RATING			FLANGE STUD TORQUE			
					ALUMINUM		OTHER MATERIAL	
IN	MM	ANSI	DIN	JIS	FT-LB	NT-M	FT-LB	NT-M
1	25	150	10/16	-	20	27	20	27
1	25	-	-	10/16/20	25	34	43	58
1	25	-	25/40	-	-	-	22	30
1	25	300/600	-	-	-	-	40	54
1	25	-	-	30/40	-	-	43	58
1	25	900/1500	-	-	-	-	125	169
1.5	40	150	-	-	20	27	25	34
1.5	40	-	10/16	10/16/20	25	34	46	62
1.5	40	300/600	-	-	-	-	82	111
1.5	40	-	25/40	-	-	-	49	66
1.5	40	-	-	30/40	-	-	92	125
1.5	40	900/1500	-	-	-	-	227	308
2	50	150	-	-	40	54	40	54
2	50	-	10/16	10	40	54	50	68
2	50	-	-	16	25	34	46	62
2	50	300/600	-	-	-	-	48	65
2	50	-	25/40	-	-	-	53	72
2	50	-	-	20/30/40	-	-	46	62
2	50	900/1500	-	-	-	-	152	206
3	80	150	-	-	40	54	50	68
3	80	-	10/16	10	40	54	46	62
3	80	-	-	16/20	60	80	90	122
3	80	300/600	-	-	-	-	92	125
3	80	-	25/40	-	-	-	50	68
3	80	-	-	30/40	-	-	92	125
3	80	900	-	-	-	-	154	209
4	100	150	-	-	40	54	45	61
4	100	-	10/16	10	40	54	47	64
4	100	300	-	16/20	40	54	90	122
4	100	-	25/40	-	50	68	98	133
4	100	600	-	-	-	-	152	206
4	100	-	-	30/40	-	-	125	169

(Table C continued on page 12)
(See notes for Table C on page 12)

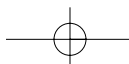

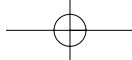

(Table C continued from page 11)

SIZE		COMPANION FLANGE RATING			FLANGE STUD TORQUE			
IN	MM	ANSI	DIN	JIS	ALUMINUM		OTHER MATERIAL	
					FT-LB	NT-M	FT-LB	NT-M
6	150	150	-	-	75	102	75	102
6	150	-	10/16	-	84	114	94	127
6	150	-	-	10	84	114	110	149
6	150	-	-	16/20	92	125	124	168
6	150	300	-	-	-	-	84	114
6	150	600	-	-	-	-	212	287
6	150	-	-	30	-	-	155	210
6	150	-	25/40	-	-	-	173	235
6	150	-	-	40	-	-	295	400
8	200	150	-	-	-	-	80	108
8	200	300	-	-	-	-	140	190
10	250	150	-	-	-	-	122	165
10	250	300	-	-	-	-	188	255
12	300	150	-	-	-	-	122	165
12	300	300	-	-	-	-	282	382
14	350	150	-	-	-	-	185	251
14	350	300	-	-	-	-	275	373
16	400	150	-	-	-	-	185	251
16	400	300	-	-	-	-	385	522
18	460	150	-	-	-	-	270	366
18	460	300	-	-	-	-	395	536
20	500	150	-	-	-	-	270	366
20	500	300	-	-	-	-	419	568
24	600	150	-	-	-	-	360	488
24	600	300	-	-	-	-	700	949
30*	750	-	-	-	-	-	297	403
36*	900	-	-	-	-	-	506	686

Torque values are based on the use of compressed fiber gaskets.

*30" and 36" torque values apply to MSS SP-44 Class 150 flanges.

The above torque values are suitable for use with studs of a minimum design stress of 25,000 psi as defined in ASME Section II Table 3. The companion flanges must be compatible for use with stud stresses up to 25,000 psi. Consult BS&B Safety Systems, L.L.C. or BS&B Safety Systems Ltd for flanges in other materials when suppliers recommend torque values lower than the BS&B Safety Systems, L.L.C. or BS&B Safety Systems Ltd recommended torque values and if gasket type differs from BS&B Safety Systems, L.L.C. or BS&B Safety Systems Ltd recommendations.

The torque values in the table above are based on the assumption of lightly oiled, clean, free running threads with a co-efficient of friction of $\mu = 0.16 \sim 0.20$. The customer is advised that the effects of corrosion, the use of particular thread compounds or dry assembly, may result in a change in the effective clamp load on the disk assembly. This may adversely affect the performance of the disk.

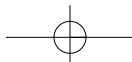

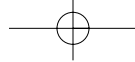
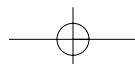
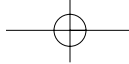

TABLE D
SRB-7RS™ ASSEMBLY
COMPANION FLANGE “J” BOLT DRILLING DIMENSIONS

SIZE		COMPANION FLANGE RATING			DIMENSIONS					
					A		B		C	
IN	MM	ANSI	DIN	JIS	IN +/- 1/32	MM +/- .8	IN +1/16 -0	MM +1.6 -0	IN	MM
1	25	150	-	-	5/16	8	7/16	11	3/8	9.5
1	25	-	10/16	-	13/32	10	5/16	8	7/16	11
1	25	-	-	10/16	9/32	7	35/64	14	7/16	11
1	25	300	-	-	7/16	11	1/2	13	3/8	9.5
1	25	-	25	-	13/32	10	5/16	8	7/16	11
1	25	-	-	20	9/32	7	5/8	16	7/16	11
1	25	600	-	-	1/2	13	5/8	16	3/8	9.5
1	25	-	40	-	13/32	10	35/64	14	7/16	11
1	25	-	-	30/40	13/32	10	6/8	16	7/16	11
1 1/2	40	150	-	-	3/8	9.5	7/16	11	7/16	11
1 1/2	40		10/16	-	13/32	10	13/32	10	7/16	11
1 1/2	40	-	-	10/16/20	11/32	9	5/8	16	7/16	11
1 1/2	40	300	-	-	1/2	13	1/2	13	7/16	11
1 1/2	40	-	25/40	-	13/32	10	13/32	10	7/16	11
1 1/2	40	-	-	30/40	7/16	11	19/32	15	7/16	11
1 1/2	40	600			9/16	14.5	1/2	13	7/16	11
2	50	150	-	-	7/16	11	7/16	11	7/16	11
2	50	-	-	10/16/20	13/32	10	7/16	11	7/16	11
2	50	-	10/16/25/40	-	15/32	12	19/32	15	7/16	11
2	50	-	-	30/40	15/32	12	5/8	16	7/16	11
2	50	300/600	-	-	9/16	14.5	11/16	17.5	7/16	11
3	80	150	-	-	5/8	16	7/16	11	7/16	11
3	80	-	-	10	13/32	10	13/32	10	7/16	11
3	80	-	10/16/25/40	-	15/32	12	13/32	10	1/2	13
3	80	-	-	16/20	1/2	13	11/32	9	7/16	11
3	80	300/600	-	-	5/8	16	13/16	20.5	7/16	11
3	80	-	-	30/40	1/2	13	19/32	15	7/16	11

(Table D continued on page 14)
(See notes for Table D on page 14)





(Table D continued from page 13)

SIZE		COMPANION FLANGE RATING			DIMENSIONS					
					A		B		C	
IN	MM	ANSI	DIN	JIS	IN +/- 1/32	MM +/- .8	IN +1/16 -0	MM +1.6 -0	IN	MM
4	100	150	-	-	5/8	16	9/16	14.5	7/16	11
4	100	-	10/16	-	15/32	12	13/32	10	19/32	15
4	100	-	-	10	13/32	10	13/32	10	7/16	11
4	100	300	-	-	5/8	16	1-1/6	27	7/16	11
4	100	-	25/40	-	15/32	12	23/32	18	19/32	15
4	100	-	-	16/20	19/32	15	1/2	13	7/16	11
4	100	600	-	-	13/16	20.5	9/16	14.5	7/16	11
4	100	-	-	30	19/32	15	25/32	20	7/16	11
4	100	-	-	40	19/32	15	1-1/32	26	7/16	11
6	150	150	-	-	5/8	16	9/16	14.5	7/16	11
6	150	-	10/16	-	15/32	12	7/16	11	5/8	16
6	150	-	-	10	35/64	14	5/16	8	7/16	11
6	150	-	-	16/20	13/32	10	15/32	12	7/16	11
6	150	300	-	-	11/16	17.5	1-5/16	33.5	7/16	11
6	150	-	25/40	-	15/32	12	3/4	19	5/8	16
6	150	600	-	-	13/16	20.5	9/16	14.5	7/16	11
6	150	-	-	30	43/64	17	1-3/16	30	7/16	11
6	150	-	-	40	43/64	17	1-49/64	45	7/16	11
8	200	150	-	-	5/8	16	1/2	13	5/8	16
8	200	300	-	-	5/8	16	1-1/4	32	5/8	16
10	250	150	-	-	5/8	16	1/2	13	5/8	16
10	250	300	-	-	5/8	16	1-1/4	32	5/8	16
12	300	150/300	-	-	5/8	16	5/8	16	5/8	16
14	350	150	-	-	5/8	16	5/8	16	5/8	16
14	350	300	-	-	31/32	25	5/8	16	5/8	16
16	400	150	-	-	5/8	16	3/8	9.5	11/16	17.5
16	400	300	-	-	5/8	16	1/2	13	11/16	17.5
18	460	150	-	-	5/8	16	1/2	13	11/16	17.5
18	460	300	-	-	5/8	16	9/16	14.5	11/16	17.5
20	500	150	-	-	5/8	16	5/8	16	11/16	17.5
20	500	300	-	-	5/8	16	5/8	16	11/16	17.5
24	600	150	-	-	5/8	16	11/16	17.5	11/16	17.5
24	600	300	-	-	5/8	16	1	25.5	11/16	17.5
30*	750	-	-	-	5/8	16	19/32	15	11/16	17.5
36*	900	-	-	-	1-1/4	32	1/2	13	11/16	17.5

*Flange diameter and stud size per MSS SP-44 Class 150 specifications.

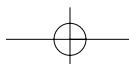

TORQUE TABLE E - Uncoated Capscrews
SRB-7FS™ (NICKEL) PRE-ASSEMBLY CAPSCREW TORQUE

SIZE		SAFETY HEAD ANSIRATING	PREASSEMBLY CAPSCREW TORQUE						12 POINT SOCKET SIZE	SOCKET DRIVE *	SUGGESTED SOCKET SOURCE SNAP-ON® TOOLS
			TYPE S90™ AND TYPE FRS™				TYPE JRS™ AND TYPE RLS™				
IN			ALUMINUM		OTHER MATERIAL		FT-LB		IN		
MM	FT-LB		NT-M	FT-LB	NT-M	FT-LB	NT-M				
1	25	150	14	19	14	19	21	28	5/16	3/8	SF-101
1	25	300/600	-	-	21	28	21	28	5/16	3/8	SF-101
1.5	40	150	24	33	24	33	36	49	3/8	3/8	SF-121
1.5	40	300/600	-	-	36	49	36	49	3/8	3/8	SF-121
2	50	150	31	42	31	42	41	56	3/8	3/8	SF-121
2	50	300/600	-	-	41	56	41	56	3/8	3/8	SF-121
3	80	150	48	65	48	65	76	103	7/16	3/8	SF-141
3	80	300/600	-	-	32	43	33	45	3/8	3/8	SF-121
4	100	150	26	35	32	43	44	60	3/8	3/8	SF-121
4	100	300	-	-	51	69	51	69	7/16	3/8	SF-141
4	100	600	-	-	62	84	62	84	7/16	3/8	SF-141
6	150	150	47	64	55	75	70	95	7/16	3/8	SF-141
6	150	300	-	-	40	54	40	54	3/8	3/8	SF-121
6	150	600	-	-	92	125	92	125	1/2	3/8	SF-161
8	200	150	-	-	70	95	84	114	7/16	3/8	SF-141
8	200	300	-	-	56	76	56	76	7/16	3/8	SF-141
10	250	150	-	-	61	83	69	94	7/16	3/8	SF-141
10	250	300	-	-	51	69	52	71	7/16	3/8	SF-141
12	300	150	-	-	68	92	69	94	7/16	3/8	SF-141
12	300	300	-	-	63	85	63	85	7/16	3/8	SF-141

*12 point, deep length, thin wall socket.

The torque values in the table above are based on the assumption of lightly oiled, clean, free running threads with a coefficient of friction of $\mu=0.16 \sim 0.20$. The affects of corrosion, the use of particular thread compounds, or dry assembly may result in a change in the effective clamp load on the disk assembly. This may adversely affect the performance of the disk. Snap-On® is a registered trademark of Snap-On Technologies Incorporated.

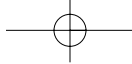

TORQUE TABLE F - Blue Coated Capscrews
SRB-7FS™ (NICKEL) PRE-ASSEMBLY CAPSCREW TORQUE
(Blue Coated Capscrews, Max Temperature 500 °F 260 °C)

SIZE		SAFETY HEAD ANSIRATING	PREASSEMBLY CAPSCREW TORQUE						12 POINT SOCKET SIZE	SOCKET DRIVE *	SUGGESTED SOCKET SOURCE SNAP-ON® TOOLS
			TYPE S90™ AND TYPE FRS™				TYPE JRS™ AND TYPE RLS™				
			ALUMINUM		OTHER MATERIAL						
IN	MM		FT-LB	NT-M	FT-LB	NT-M	FT-LB	NT-M	IN	IN	
1	25	150	7	9	7	9	11	15	5/16	3/8	SF-101
1	25	300/600	-	-	11	15	11	15	5/16	3/8	SF-101
1.5	40	150	12	16	12	16	18	24	3/8	3/8	SF-121
1.5	40	300/600	-	-	18	24	18	24	3/8	3/8	SF-121
2	50	150	16	22	16	22	21	28	3/8	3/8	SF-121
2	50	300/600	-	-	21	28	21	28	3/8	3/8	SF-121
3	80	150	24	33	24	33	38	52	7/16	3/8	SF-141
3	80	300/600	-	-	16	22	17	23	3/8	3/8	SF-121
4	100	150	13	18	16	22	22	30	3/8	3/8	SF-121
4	100	300	-	-	26	35	26	35	7/16	3/8	SF-141
4	100	600	-	-	31	42	31	42	7/16	3/8	SF-141
6	150	150	24	33	28	38	35	47	7/16	3/8	SF-141
6	150	300	-	-	20	27	20	27	3/8	3/8	SF-121
6	150	600	-	-	46	62	46	62	1/2	3/8	SF-161
8	200	150	-	-	35	47	42	57	7/16	3/8	SF-141
8	200	300	-	-	28	38	28	38	7/16	3/8	SF-141
10	250	150	-	-	31	42	35	47	7/16	3/8	SF-141
10	250	300	-	-	26	35	26	35	7/16	3/8	SF-141
12	300	150	-	-	34	46	35	47	7/16	3/8	SF-141
12	300	300	-	-	32	43	32	43	7/16	3/8	SF-141

*12 point, deep length, thin wall socket.

Do not lubricate blue fluoropolymer coated capscrews.

Snap-On® is a registered trademark of Snap-On Technologies Incorporated.

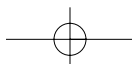

TORQUE TABLE G - Uncoated Capscrews

SRB-7FS™ (with RTJ) PRE-ASSEMBLY CAPSCREW TORQUE

SIZE		SAFETY HEAD ANSIRATING	PREASSEMBLY CAPSCREW TORQUE						12 POINT SOCKET SIZE	SOCKET DRIVE *	SUGGESTED SOCKET SOURCE SNAP-ON® TOOLS
			TYPE S90™ AND TYPE FRS™				TYPE JRS™ AND TYPE RLS™				
IN	MM		ALUMINUM		OTHER MATERIAL		FT-LB	NT-M	IN	IN	
1	25	150	11	15	11	15	17	23	1/4	3/8	SF-081
1	25	300/600	-	-	17	23	17	23	1/4	3/8	SF-081
1.5	40	150	20	27	20	27	30	41	5/16	3/8	SF-101
1.5	40	300/600	-	-	30	41	30	41	5/16	3/8	SF-101
2	50	150	26	35	26	35	34	46	5/16	3/8	SF-101
2	50	300/600	-	-	34	46	34	46	5/16	3/8	SF-101
3	80	150	41	55	41	55	65	88	3/8	3/8	SF-121
3	80	300/600	-	-	65	88	65	88	3/8	3/8	SF-121
4	100	150	22	30	28	38	35	47	5/16	3/8	SF-101
4	100	300	-	-	44	60	44	60	3/8	3/8	SF-121
4	100	600	-	-	53	72	53	72	3/8	3/8	SF-121
6	150	150	40	54	47	64	60	81	3/8	3/8	SF-121
6	150	300	-	-	33	45	33	45	5/16	3/8	SF-101
6	150	600	-	-	81	110	81	110	7/16	3/8	SF-141
8	200	150	-	-	70	95	84	114	7/16	3/8	SF-141
8	200	300	-	-	48	65	48	65	3/8	3/8	SF-121
10	250	150	-	-	52	71	59	80	3/8	3/8	SF-121
10	250	300	-	-	44	60	44	60	3/8	3/8	SF-121
12	300	150	-	-	58	79	59	80	3/8	3/8	SF-121
12	300	300	-	-	54	73	54	73	3/8	3/8	SF-121

*12 point, deep length, thin wall socket.

The torque values in the table above are based on the assumption of lightly oiled, clean, free running threads with a coefficient of friction of $\mu=0.16 \sim 0.20$. The affects of corrosion, the use of particular thread compounds, or dry assembly may result in a change in the effective clamp load on the disk assembly. This may adversely affect the performance of the disk. Snap-On® is a registered trademark of Snap-On Technologies Incorporated.

TORQUE TABLE H - Blue Coated Capscrews
SRB-7FS™ (with RTJ) PRE-ASSEMBLY CAPSCREW TORQUE
(Blue Coated Capscrews, Max Temperature 500 °F 260 °C)

SIZE		SAFETY HEAD ANSIRATING	PREASSEMBLY CAPSCREW TORQUE						12 POINT SOCKET SIZE	SOCKET DRIVE *	SUGGESTED SOCKET SOURCE SNAP-ON® TOOLS
			TYPE S90™ AND TYPE FRS™				TYPE JRS™ AND TYPE RLS™				
			ALUMINUM		OTHER MATERIAL						
IN	MM		FT-LB	NT-M	FT-LB	NT-M	FT-LB	NT-M	IN	IN	
1	25	150	6	8	6	8	9	12	1/4	3/8	SF-081
1	25	300/600	-	-	9	12	9	12	1/4	3/8	SF-081
1.5	40	150	10	14	10	14	15	20	5/16	3/8	SF-101
1.5	40	300/600	-	-	15	20	15	20	5/16	3/8	SF-101
2	50	150	13	18	13	18	17	23	5/16	3/8	SF-101
2	50	300/600	-	-	17	23	17	23	5/16	3/8	SF-101
3	80	150	21	28	21	28	33	45	3/8	3/8	SF-121
3	80	300/600	-	-	33	45	33	45	3/8	3/8	SF-121
4	100	150	11	15	14	19	18	24	5/16	3/8	SF-101
4	100	300	-	-	22	30	22	30	3/8	3/8	SF-121
4	100	600	-	-	27	37	27	37	3/8	3/8	SF-121
6	150	150	20	27	24	33	30	41	3/8	3/8	SF-121
6	150	300	-	-	17	23	17	23	5/16	3/8	SF-101
6	150	600	-	-	41	56	41	56	7/16	3/8	SF-141
8	200	150	-	-	35	47	42	57	7/16	3/8	SF-141
8	200	300	-	-	24	33	24	33	3/8	3/8	SF-121
10	250	150	-	-	26	35	30	41	3/8	3/8	SF-121
10	250	300	-	-	22	30	22	30	3/8	3/8	SF-121
12	300	150	-	-	29	39	30	41	3/8	3/8	SF-121
12	300	300	-	-	27	37	27	37	3/8	3/8	SF-121

*12 point, deep length, thin wall socket.

Do not lubricate blue fluoropolymer coated capscrews.

Snap-On® is a registered trademark of Snap-On Technologies Incorporated.



TABLE I
SRB-7FS™ AND SRB-7FS™ WITH RTJ ASSEMBLIES
COMPANION FLANGE “J” BOLT DRILLING DIMENSIONS

SIZE IN	ANSI FLANGE RATING	SRB-7FS™ ASSEMBLIES			SRB-7FS™ W/RTJ ASSEMBLIES		
		DIMENSION A ± 1/32 IN	DIMENSION B + 1/16 IN - 0	DIMENSION C IN	DIMENSION A ± 1/32 IN	DIMENSION B + 1/16 IN - 0	DIMENSION C IN
1	150	5/16	1/2	7/16	17/32	1/2	1/2
	300	1/2	1/2	7/16	5/8	1/2	1/2
	600	1/2	1/2	7/16	5/8	1/2	1/2
1.5	150	5/16	1/2	7/16	5/8	1/2	1/2
	300	1/2	1/2	7/16	5/8	1/2	1/2
	600	1/2	1/2	7/16	5/8	1/2	1/2
2	150	1/2	1/2	7/16	5/8	1/2	1/2
	300	1/2	1/2	7/16	13/16	1/2	1/2
	600	1/2	1/2	7/16	13/16	1/2	1/2
3	150	3/4	1/2	7/16	5/8	1/2	1/2
	300	3/4	1/2	7/16	3/4	1/2	5/8
	600	3/4	1/2	7/16	3/4	1/2	5/8
4	150	3/4	1/2	7/16	5/8	1/2	5/8
	300	3/4	1/2	7/16	3/4	1/2	5/8
	600	3/4	1/2	7/16	3/4	1/2	5/8
6	150	7/8	1/2	7/16	5/8	1/2	5/8
	300	7/8	1/2	7/16	3/4	1/2	5/8
	600	7/8	1/2	7/16	3/4	1/2	5/8
8	150	3/4	1/2	5/8	7/8	1/2	3/4
	300	3/4	1/2	5/8	13/16	1/2	3/4
10	150	3/4	1/2	5/8	7/8	1/2	3/4
	300	3/4	1/2	5/8	13/16	1/2	3/4
12	150	3/4	1/2	5/8	7/8	1/2	3/4
	300	3/4	1/2	5/8	13/16	1/2	3/4

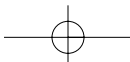

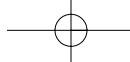

TORQUE TABLE J
COMPANION FLANGE STUD TORQUE
FOR S90-7R™ (Unlined disks only)

SIZE		COMPANION FLANGE RATING	FLANGE STUD TORQUE			
			TYPE S-90™ AND TYPE FRS™			
			ALUMINUM		OTHER MATERIAL	
IN	MM	ANSI	FT-LB	NT-M	FT-LB	NT-M
1	25	150	20	27	22	30
1	25	300/600	-	-	43	58
1 1/2	40	150	20	27	32	43
1 1/2	40	300/600	-	-	72	98
2	50	150	40	54	52	71
2	50	300/600	-	-	42	57
3	80	150	40	54	68	92
3	80	300/600	-	-	79	107
4	100	150	40	54	54	73
4	100	300	-	-	87	118
4	100	600	-	-	119	161
6	150	150	80	108	95	129
6	150	300	-	-	80	108
6	150	600	-	-	185	251
8	200	150	-	-	120	163
8	200	300	-	-	140	190
10	250	150	-	-	122	165
10	250	300	-	-	188	255
12	300	150	-	-	136	184
12	300	300	-	-	272	369
14	350	150	-	-	206	279
14	350	300	-	-	251	340
16	400	150	-	-	182	247
16	400	300	-	-	390	529
18	460	150	-	-	270	366
18	460	300	-	-	390	529
20	500	150	-	-	270	366
20	500	300	-	-	390	529
24	600	150	-	-	390	529
24	600	300	-	-	700	949
30*	750	-	-	-	297	403

Torque values are based on the use of compressed fiber gaskets.

* 30" torque value applies to MSS SP-44 Class 150 flanges.

The above torque values are suitable for use with studs of a minimum design stress of 25,000 psi as defined in ASME Section II Table 3. The companion flanges must be compatible for use with stud stresses up to 25,000 psi. Consult BS&B Safety Systems, L.L.C. or BS&B Safety Systems Ltd for flanges in other materials when suppliers recommend torque values lower than the BS&B Safety Systems, L.L.C. or BS&B Safety Systems Ltd recommended torque values and if gasket type differs from BS&B Safety Systems, L.L.C. or BS&B Safety Systems Ltd recommendations.

The torque values in the table above are based on the assumption of lightly oiled, clean, free running threads with a co-efficient of friction of $\mu = 0.16 \sim 0.20$. The customer is advised that the effects of corrosion, the use of particular thread compounds or dry assembly, may result in a change in the effective clamp load on the disk assembly. This may adversely affect the performance of the disk.

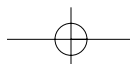

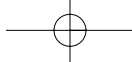

TORQUE TABLE K

SRB-7RS™ COMPANION FLANGE STUDS

SIZE		COMPANION FLANGE RATING			NUMBER OF STUDS	DIAMETER OF STUD		MINIMUM LENGTH OF STUD	
IN	MM	ANSI	DIN	JIS		IN	MM	IN	MM
1	25	150	-	-	4	1/2	-	4-1/2	-
1	25	300	-	-	4	5/8	-	5-1/2	-
1	25	600	-	-	4	5/8	-	5-1/2	-
1	25	900/1500	-	-	4	5/8	-	8-1/2	-
1	25	-	10/16/25/40	-	4	-	12	-	125
1	25	-	-	10/16/20	4	-	16	-	135
1	25	-	-	30/40	4	-	16	-	135
1 1/2	40	150	-	-	4	1/2	-	5	-
1 1/2	40	300/600	-	-	4	3/4	-	6-1/2	-
1 1/2	40	900/1500	-	-	4	1	-	8-1/2	-
1 1/2	40	-	10/16/25/40	-	4	-	16	-	135
1 1/2	40	-	-	10/16/20	4	-	16	-	140
1 1/2	40	-	-	30/40	4	-	20	-	150
2	50	150	-	-	4	5/8	-	6-1/2	-
2	50	300	-	-	8	5/8	-	6-1/2	-
2	50	600	-	-	8	5/8	-	6-1/2	-
2	50	900/1500	-	-	8	5/8	-	9-1/2	-
2	50	-	10/16/25/40	-	4	-	16	-	145
2	50	-	-	10	4	-	16	-	140
2	50	-	-	16/20	8	-	16	-	140
2	50	-	-	30/40	8	-	16	-	155
3	80	150	-	-	4	5/8	-	6-1/2	-
3	80	300	-	-	8	3/4	-	7-1/2	-
3	80	600	-	-	8	3/4	-	7-1/2	-
3	80	900	-	-	8	5/8	-	10	-
3	80	1500	-	-	8	1-1/8	-	12-1/2	-
3	80	-	10	-	8	-	16	-	155
3	80	-	16/25/40	-	8	-	16	-	160
3	80	-	-	10	8	-	16	-	155
3	80	-	-	16/20	8	-	20	-	165
3	80	-	-	30/40	8	-	20	-	185

(Table K continued on page 22)
(See notes for Table K on page 22)

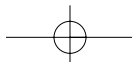

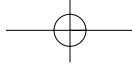

(Table K continued from page 21)

SIZE		COMPANION FLANGE RATING			NUMBER OF STUDS	DIAMETER OF STUD		MINIMUM LENGTH OF STUD	
IN	MM	ANSI	DIN	JIS		IN	MM	IN	MM
4	100	150	-	-	8	5/8	-	7-1/2	-
4	100	300	-	-	8	3/4	-	8-1/2	-
4	100	600	-	-	8	7/8	-	8	-
4	100	-	10/16	10	8	-	16	-	180
4	100	-	25/40	-	8	-	21	-	185
4	100	-	-	16/20	8	-	20	-	195
4	100	-	-	30/40	8	-	22	-	210
6	150	150	-	-	8	3/4	-	8-3/4	-
6	150	300	-	-	12	3/4	-	9-1/2	-
6	150	600	-	-	12	1	-	10-1/2	-
6	150	-	10/16	-	8	-	21	-	205
6	150	-	25/40	-	8	-	25	-	225
6	150	-	-	10	8	-	20	-	205
6	150	-	-	16/20	12	-	22	-	235
6	150	-	-	30	12	-	24	-	245
6	150	-	-	40	12	-	30	-	270
8	200	150	-	-	8	3/4	-	9	-
8	200	300	-	-	12	7/8	-	10	-
10	250	150	-	-	12	7/8	-	9-1/2	-
10	250	300	-	-	16	1	-	11	-
12	300	150	-	-	12	7/8	-	10-1/2	-
12	300	300	-	-	16	1-1/8	-	12-1/2	-
14	350	150	-	-	12	1	-	11-1/2	-
14	350	300	-	-	20	1-1/8	-	14	-
16	400	150	-	-	16	1	-	13	-
16	400	300	-	-	20	1-1/4	-	16	-
18	460	150	-	-	16	1-1/8	-	14-1/2	-
18	460	300	-	-	24	1-1/4	-	16-1/2	-
20	500	150	-	-	20	1-1/8	-	16	-
20	500	300	-	-	24	1-1/4	-	18	-
24	600	150	-	-	20	1-1/4	-	18	-
24	600	300	-	-	24	1-1/2	-	21	-
30*	750	-	-	-	28	1-1/4	-	21-1/2	-
36*	900	-	-	-	32	1-1/2	-	26-1/2	-

* Flange diameter and stud size per MSS SP-44 Class 150 specifications.

For other Safety Head types, consult BS&B Safety Systems, L.L.C. or BS&B Safety Systems Ltd.

This data assumes the use of a standard specification SRB-7RS™ Safety Head as indicated in Catalog 77-4001

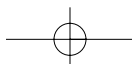

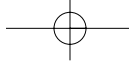

Limitations of Warranties – BS&B Safety Systems, L.L.C. and BS&B Safety Systems Ltd. warrants their products, when properly installed, used and maintained by the original purchaser, against defective workmanship and materials for a period of twelve (12) months from the date of shipment. Purchaser's failure to use this product in strict compliance with all material operating specifications provided to BS&B Safety Systems, L.L.C. or BS&B Safety Systems Ltd. by purchaser prior to BS&B Safety Systems, L.L.C. or BS&B Safety Systems Ltd. production or shipment of this product shall void this warranty. Rupture Disks are warranted solely to burst within specified pressure ranges at temperatures specified at the time of sale.

Where pressure relief or other products used by Buyer involve multi-part assemblies, each part must be manufactured by BS&B Safety Systems, L.L.C. or BS&B Safety Systems Ltd. BS&B Safety Systems, L.L.C. and BS&B Safety Systems Ltd. specifically disclaim any warranties and any and all liability for damages, either direct or indirect, incidental or consequential, arising from the use of Rupture Disk assemblies (e.g. Rupture Disk and Rupture Disk holder), explosion vent assemblies (e.g. vent and safety frame) or other assemblies not wholly comprised of BS&B Safety Systems, L.L.C. and BS&B Safety Systems Ltd. manufactured products.

BS&B Safety Systems, L.L.C. and BS&B Safety Systems Ltd. do not warrant any article not manufactured by BS&B Safety Systems, L.L.C. or BS&B Safety Systems Ltd. BS&B Safety Systems, L.L.C. and BS&B Safety Systems Ltd. do not warrant this product against loss or damage caused directly or indirectly by improper pressure relief system design; by the improper use, maintenance or installation (including improper torque) of this product; or by corrosion erosion or malfunction caused by acids, chemicals, fumes, rust, dirt, debris, thermal shock, shock waves or other external agencies over which BS&B Safety Systems, L.L.C. and BS&B Safety Systems Ltd. have no control.

THE EXPRESSED WARRANTIES HEREIN GIVEN ARE EXCLUSIVE AND IN LIEU OF ALL WARRANTIES EXPRESSED OR IMPLIED, BY OPERATION OF LAW OR OTHERWISE, INCLUDING, WITHOUT LIMITATION, ANY IMPLIED WARRANTY OF MERCHANTABILITY OR FITNESS FOR A PARTICULAR PURPOSE. BUYER'S SOLE AND EXCLUSIVE REMEDY FOR BREACH OF ANY WARRANTY SHALL BE, AT BS&B Safety Systems, L.L.C. OR BS&B SAFETY SYSTEMS LTD. OPTION, THE REPAIR OR REPLACEMENT OF THE PRODUCT, F.O.B. TULSA, OKLAHOMA, OR LIMERICK, IRELAND.

Liability Limitations – BS&B Safety Systems, L.L.C. and BS&B Safety Systems Ltd. manufacture and supply their products in reliance upon information and specifications provided by its customers. BS&B Safety Systems, L.L.C. and BS&B Safety Systems Ltd. specifically disclaim any and all liability, of whatever nature, resulting or arising from Buyer's failure to disclose fully all material operating conditions, design parameters, process components, or system or vessel requirements, or from any misrepresentations or omissions by Buyer, Buyer agrees to indemnify and hold harmless BS&B Safety Systems, L.L.C. or BS&B Safety Systems Ltd. for all costs, loss, liability or damage arising or resulting from BS&B Safety Systems, L.L.C. or BS&B Safety Systems Ltd. manufacture or supply of this product in accordance with Buyer's specifications or requirements.

BS&B Safety Systems, L.L.C. OR BS&B SAFETY SYSTEMS LTD. AGGREGATE TOTAL LIABILITY TO BUYER FOR ANY AND ALL LOSS OR DAMAGE ARISING OUT OF BUYER'S USE OF, OR INABILITY TO USE, THE PRODUCT SHALL IN NO EVENT EXCEED THE PURCHASE PRICE OF THE PRODUCT OR \$1,000.00, WHICHEVER IS LESSER, BS&B Safety Systems, L.L.C. OR BS&B SAFETY SYSTEMS LTD. SHALL NOT BE LIABLE FOR PERSONAL INJURY OR PROPERTY DAMAGE ARISING OUT OF BUYER'S PURCHASE, INSTALLATION OR USE OF THE PRODUCT, AND IN NO EVENT SHALL BS&B Safety Systems, L.L.C. OR BS&B SAFETY SYSTEMS LTD. BE LIABLE FOR SPECIAL, INCIDENTAL, CONSEQUENTIAL OR PUNITIVE DAMAGES RESULTING FROM ANY SUCH CAUSES.

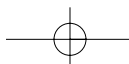

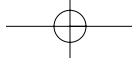

BS&B Safety Systems, L.L.C.
7455 East 46th Street
Tulsa, OK 74145
Telephone: 918-622-5950
Facsimile: 918-665-3904
sales@tul.bsbsystems.com
www.bsbsystems.com



BS&B SAFETY SYSTEMS, L.L.C.
BS&B SAFETY SYSTEMS, LTD.

BS&B Safety Systems Ltd.
Raheen Business Park
Raheen, Limerick, Ireland
Telephone: +353 61 227022
Facsimile: +353 61 227987
sales@bsb.ie
www.bsb.ie

BS&B Safety Systems, L.L.C. and BS&B Safety Systems Ltd. are here to assist you in providing a safe and efficient work place. For assistance on installation, audits, training or technical advice, please contact our Customer Service Department.

